

# ARCSERVE UDP

Technical Whitepaper



## CONTENTS

1	<b>Overview</b>	3
2	<b>Three Reasons to switch to Arcserve UDP</b>	4
3	<b>Flexible Architecture</b>	5
4	<b>Key Features</b>	6
4.2	<b>Quick Recovery</b>	6
4.2	<b>Deep Cloud Integration</b>	6
4.3	<b>Comprehensive Backup</b>	6
4.4	<b>Streamlined Management and Advanced Reporting</b>	6
5	<b>Arcserve UDP Components</b>	7
5.1	<b>Unified Management Console (UDP Console)</b>	7
5.2	<b>Recovery Point Server (RPS)</b>	7
5.3	<b>Agentless VM Backup Proxy</b>	8
5.4	<b>Agent</b>	9
5.5	<b>Scalable Architecture</b>	9
5.6	<b>Arcserve 9000 Series Appliances</b>	10
6	<b>Fast and Flexible Recovery Options</b>	11
6.1	<b>Bare Metal Recovery (BMR)</b>	11
6.2	<b>Virtual Standby</b>	12
6.3	<b>Instant VM</b>	12
6.4	<b>Instant Bare Metal Recovery (BMR)</b>	12
6.5	<b>Application Recovery</b>	13
6.6	<b>Granular Recovery</b>	13
6.7	<b>Assured Recovery</b>	13
7	<b>Deep Cloud Integration</b>	14
7.1	<b>Disaster Recovery in the Cloud</b>	14
7.2	<b>Backup to the Cloud</b>	15
7.3	<b>Protect Workloads in Amazon AWS, Microsoft Azure and Other Clouds</b>	15
7.4	<b>Protect Microsoft Office 365</b>	16
7.4.1	<b>Protect Emails in Exchange Online</b>	16
7.4.2	<b>Protect SharePoint Online Sites</b>	17
7.4.3	<b>Protect User Files on OneDrive for Business</b>	17
7.5	<b>Deploy Arcserve UDP in the Cloud</b>	17
8	<b>Comprehensive Backup and Management</b>	18
8.1	<b>Data Protection Plans</b>	18
8.2	<b>Global Source, Block-Level Deduplication and WAN optimization</b>	18
8.3	<b>Backup Replication and Retention</b>	19
8.4	<b>Hardware Snapsh</b>	19
8.5	<b>Tape Integration</b>	20
8.6	<b>RPS Jumpstart or “Offline” Synchronization</b>	20
8.7	<b>Storage Multi-Tenancy</b>	21
8.8	<b>Monitoring, Alerting and Advanced Reporting</b>	22
9	<b>Summary</b>	24
10	<b>About Arcserve</b>	24



# 1 OVERVIEW

**Arcserve Unified Data Protection (UDP)** combines industry-proven disaster recovery, backup and true global deduplication technologies into an all-in-one solution that delivers every data protection capability you and your business need through one stunningly simple management console.

Powered by heterogeneous, image-based technology that protects to and from any target, it unifies enterprise-ready features without the complexity of traditional solutions.

Eliminate the need for discrete products, and:

- **Safeguard** your systems and applications in cloud, virtual and physical environments
- **Reduce** the risks of extended downtime by cutting RTOs and RPOs from days to minutes
- **Scale** up, down and out to the cloud on-demand, turning capabilities on and off without forklift upgrades
- **Validate** your RTOs, RPOs, and SLAs with built-in Assured Recovery™ testing
- **Amplify** storage efficiency by up to 20x with built-in global, source-side deduplication
- **Reclaim** up to 50% more time to spend on strategic IT initiatives

Arcserve UDP is based on a unified architecture for your entire IT ecosystem – including virtual, physical and cloud environments. It includes innovative features such as:

- Unified management console
- Simple task-based data protection and availability plans
- Agentless backup for VMware vSphere, Microsoft Hyper-V and Nutanix AHV
- Backup of physical Windows and Linux servers
- Backup of, and recovery to, Amazon AWS EC2 and Microsoft Azure
- True global, source, block-level deduplication
- Advanced tape support, including single drives and tape libraries
- Virtual Standby for proactive Disaster Recovery
- Instant VM Recovery for DR on-demand
- Instant Bare Metal Restore
- Reboot-less Agent deployment
- Role-based access control and user administration



## 2 THREE REASONS TO SWITCH TO ARCSERVE UDP

- Spend 50% less time managing backups** and simplify DR and data protection dramatically with unified management, and centralized reporting and deployment, when compared to point solutions.
- Protect your entire IT** with an industry-broadest set of enterprise-level functionality in a single solution that's easy to deploy, use and manage - on-premises, off-premises and in the cloud, and across a multitude of platforms. Protect your cloud applications and leverage hyperscale cloud infrastructures for optimized Disaster Recovery.
- Automate your DR testing** with Assured Recovery™ – the market's most robust automated DR testing of business-critical systems, applications and data without maintenance windows, downtime, or impact to production systems.

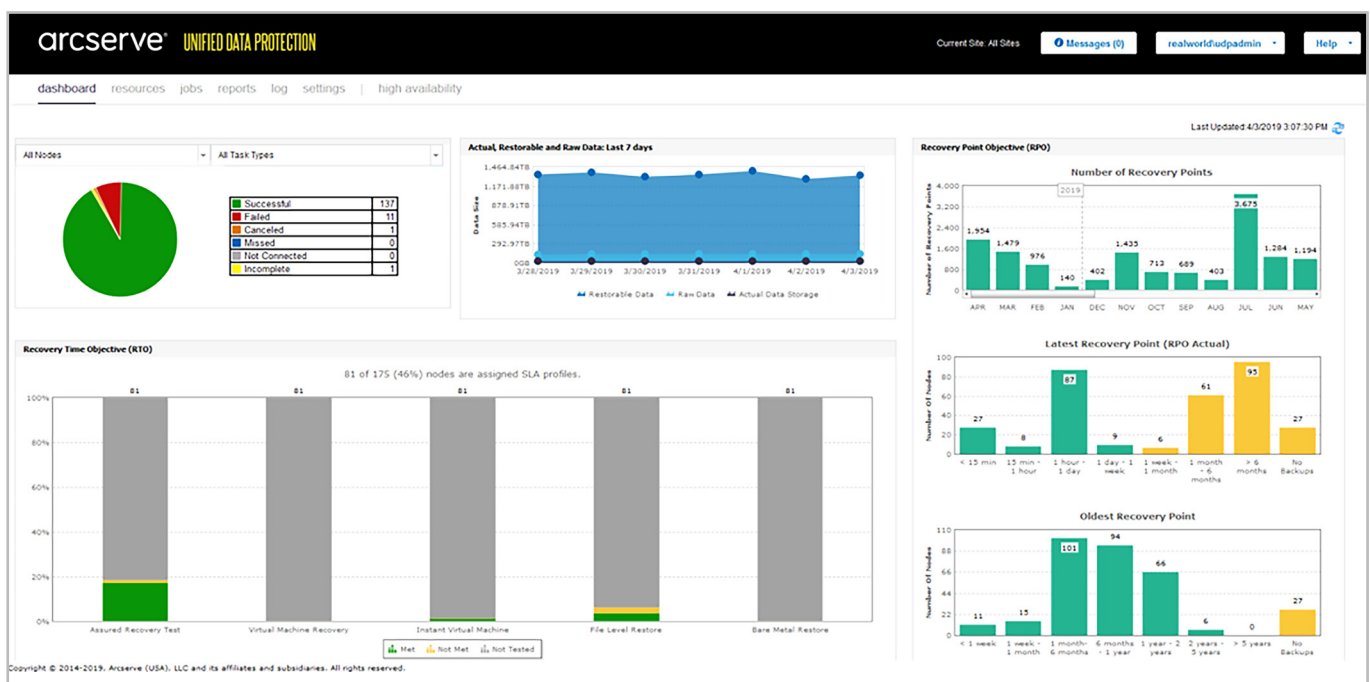

### 3 FLEXIBLE ARCHITECTURE

The unified architecture of Arcserve UDP matches the growth of your IT infrastructure, consisting of the elements that reside on a single server or distributed across multiple physical or virtual servers to enable full scalability.

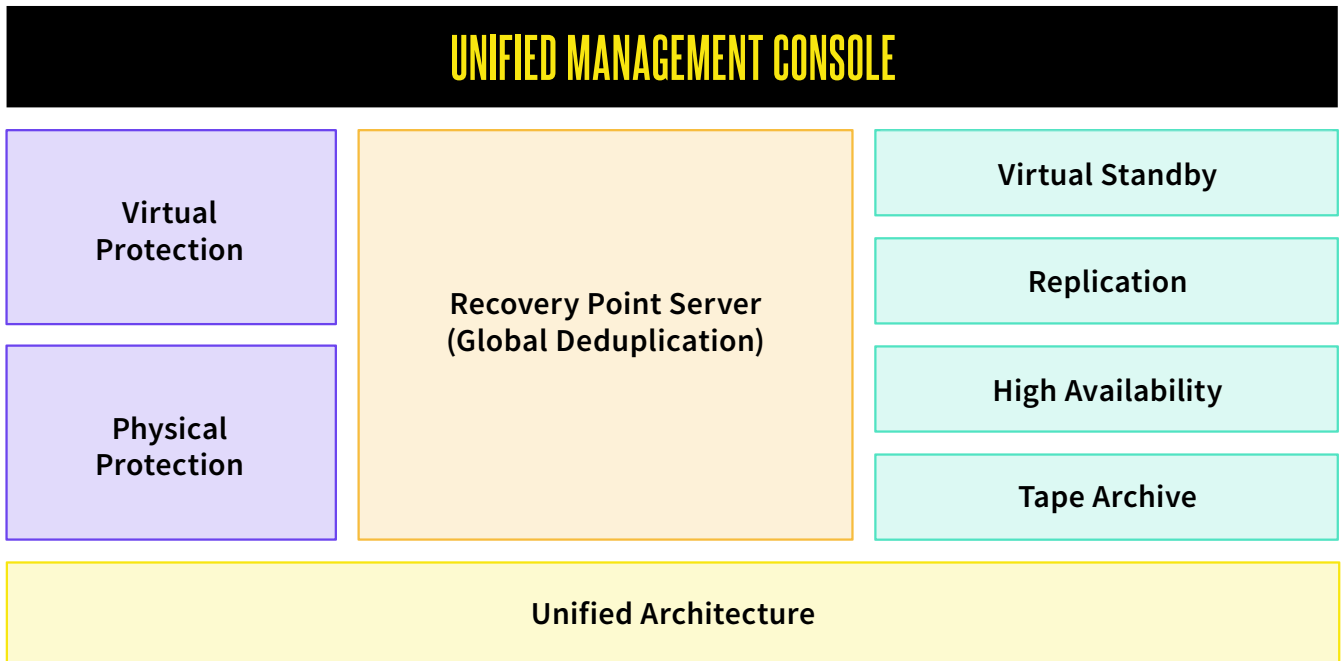

## 4 KEY FEATURES

### 4.1 Quick Recovery

- **Virtual Standby** – maintain virtual copies of mission-critical systems on Nutanix AHV, VMware vSphere, Microsoft Hyper-V, Amazon AWS EC2 and Microsoft Azure for fast boot-up
- **Instant VM** – spin up business-critical system backups as virtual machines on-demand in Nutanix AHV, VMware vSphere, Microsoft Hyper-V, Amazon AWS EC2 and Microsoft Azure
- **Assured Recovery™** – schedule automated disaster recovery tests with advanced reporting for stakeholders
- **Granular Recovery** – restore individual files, mailboxes, emails, Active Directory objects, SharePoint databases, site collections, sites, lists, and list items
- **Mount Backups** – attach backups as virtual drives in Windows and NFS shares in Linux for advanced insights

### 4.2 Deep Cloud Integration

- **Cloud Disaster Recovery** – run critical systems in the Arcserve Cloud, AWS and Azure after a disaster
- **Cloud Backup** – store copies of your backups in the Arcserve Cloud, Amazon AWS, Microsoft Azure and more clouds
- **Amazon AWS and Microsoft Azure** – protect your workloads from data loss and extended downtimes
- **Microsoft Office 365** – safeguard your emails, documents and files from data loss
- **Cloud Deployment** – install Arcserve UDP in Amazon AWS, Microsoft Azure, VMware vCloud Air, NTT Enterprise Cloud or Fujitsu Cloud Service for OSS for cloud-to-cloud backup with deduplication

### 4.3 Comprehensive Backup

- **Agentless VM Backup** – protect Nutanix AHV, VMware vSphere and Microsoft Hyper-V, with automatic protection of newly added VMs
- **Advanced Deduplication** – increase storage efficiency with true global, at-source deduplication
- **Built-in WAN-optimization** – decrease bandwidth requirements for cloud and remote site backup
- **Advanced Security** – safeguard the data in-flight and at-rest with built-in AES/SSL encryption and TLS 1.2
- **Hardware Snapshot** – HPE 3Par, Nimble Storage and NetApp ONTAP

### 4.4 Streamlined Management and Advanced Reporting

- **Web-based Console** – save time with a fully-unified, streamlined user interface
- **Role-based Administration** – assure security with complete access control
- **Policy-Based Management** – scale disaster recovery and backup without extra effort
- **SLA Reporting** – keep business stakeholders informed with RTO and RTA (Actual) comparisons
- **CLI, API and DB integration** – advanced capabilities for deeper customization



## 5 ARCSERVE UDP COMPONENTS

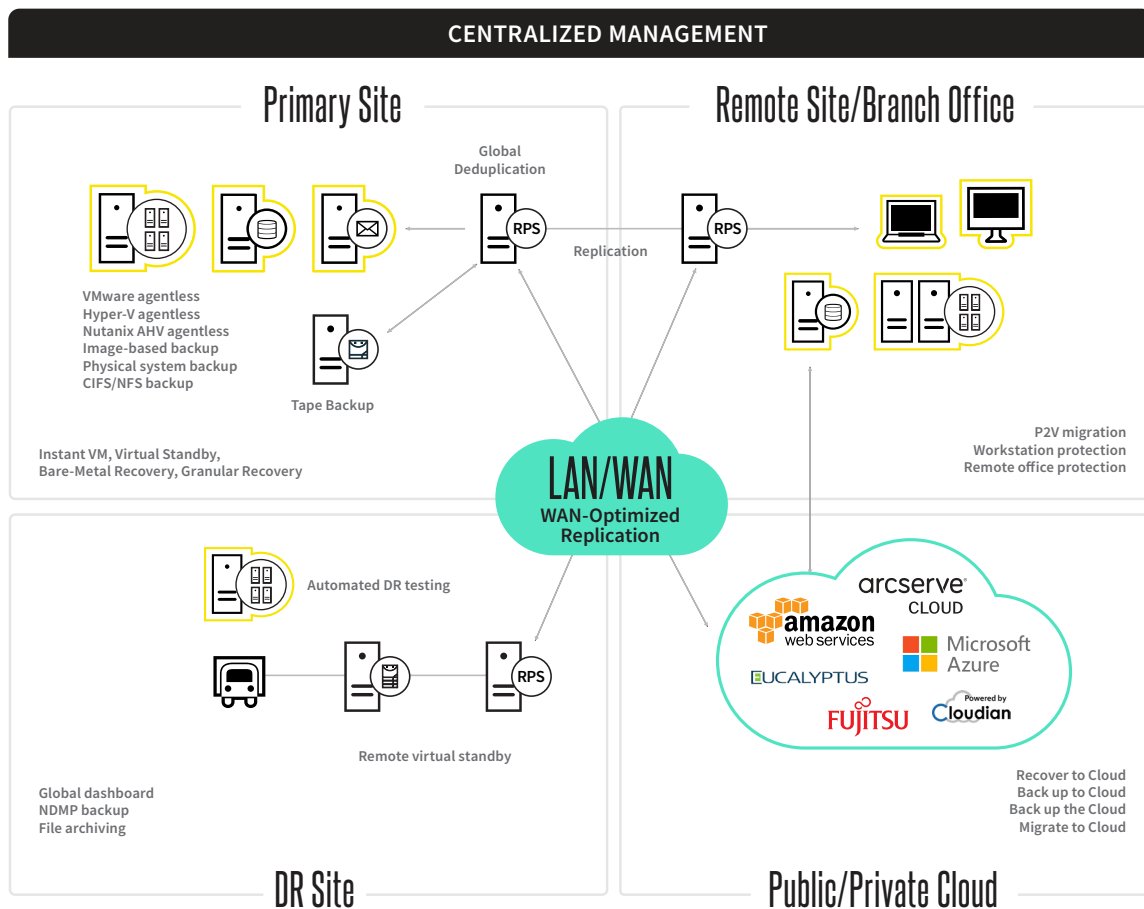

### 5.1 Unified Management Console (UDP Console)

The console provides administrators with a single, web-based management console to easily and quickly manage the entire Arcserve UDP environment. A wizard-driven user interface further simplifies deployment, management, reporting and tape integration.

### 5.2 Recovery Point Server (RPS)

The Recovery Point Server (RPS) boasts a unique set of technologies that provide the fundamental building blocks of the Arcserve UDP solution. Key features of RPS include:

- Global, source, block-level deduplication
- Backup replication and retention
- RPS jumpstart or “offline” synchronization
- Storage multi-tenancy
- Monitoring, alerting and advanced reporting

More details are available in the “Comprehensive Backup Capabilities” chapter below.



## 5.3 Agentless VM Backup Proxy

The Host-Based/Agentless Backup Proxy enables a single-pass backup of virtual machines, without the need to install agents on each VM:

- Fast, single-pass backup of VMs on VMware, Hyper-V and Nutanix AHV environments
- Centralized node, group and plan management from the unified management console
- Integration with hypervisor APIs, including VADP, VAAI, VSS and Nutanix AHV API
- VSS integration for application-consistent backups
- Auto-discovery of VMs via integration with vSphere vCenter, Hyper-V management console and Nutanix PRISM
- Incremental backup of changed blocks enabled by VMware vSphere and Nutanix AHV Changed Block Tracking (CBT), proprietary Arcserve CBT for Windows Server 2012 Hyper-V, as well as Windows Server 2016 Hyper-V Resilient Change Tracking (RCT)
- Granular file- and folder-level recovery from Windows and Linux VMs

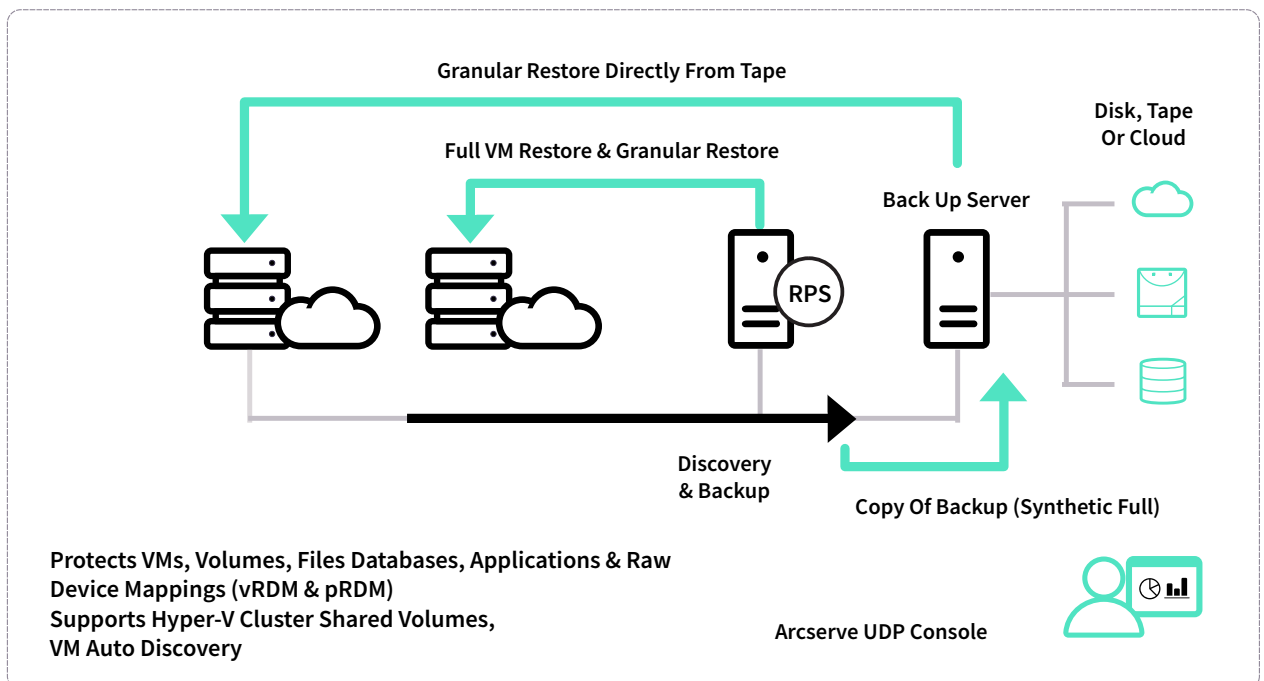



## 5.4 Agent

The Arcserve UDP Agent can be installed on physical systems, virtual machines or cloud instances to allow users to back up and restore locally, or to be managed centrally by the UDP console.

## 5.5 Scalable Architecture

Arcserve UDP can scale to protect any IT environment – from a few servers in small or remote environment, to hundreds and even thousands of systems in larger data centers.

Arcserve UDP components can be installed on the same systems or distributed to ensure maximum performance and efficiency of data protection.

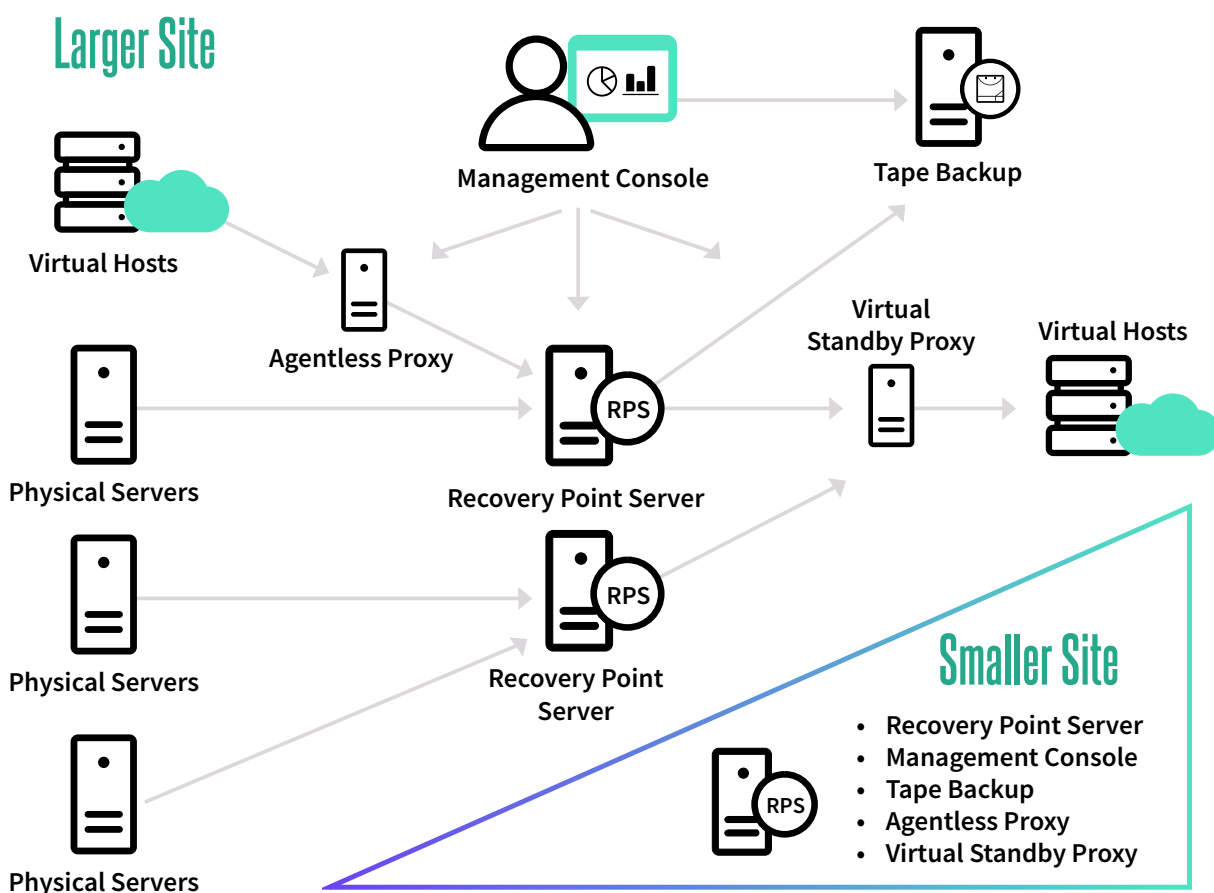

## 5.6 Arcserve 9000 Series Appliances

The Arcserve® 9000 Appliance Series is the only complete and cost-effective DR and backup solution, powered by Arcserve UDP software, enabling you to deploy an all-in-one data protection strategy in just 15 minutes flat.

This turnkey solution bundles robust server processing, flash-accelerated deduplicated storage, and high-speed networking with enterprise-grade hardware to make it easier to deliver reliable disaster recovery, assure application availability, keep up with data growth, reduce time managing backups and gain peace of mind.

The Arcserve 9000 Appliance Series includes:

- Up to 20 CPU cores and 768GB RAM to spin up dozens of VMs in case of failures
- Up to 504TB effective capacity of a single appliance, with up to 6PB of backups managed via a single user interface
- Easy-to-install Expansion Kits to increase capacity and meet your data growth demands
- Up to 20:1 deduplication ratio and extreme, flash-accelerated deduplication performance with enterprise-grade SAS, HDDs and SSDs
- 12Gbps RAID cards with 2GB NV cache and redundant hot-swap power supplies for high-performance and reliability
- On-site support in as little as four hours for peace of mind

Eleven models are available in the 9000 Series:

Model	Effective Capacity	Usable Capacity	Form Factor	CPU	RAM	SSD
<b>9012</b>	12	4	1U	Single	48 GB	480 GB
<b>9024</b>	24	8				
<b>9048</b>	48	16				
<b>9072DR</b>	72	24	2U	Dual	192 GB	2x 1.9 TB
<b>9096DR</b>	96	32				
<b>9144DR</b>	144	48				
<b>9192DR</b>	192	64				
<b>9240DR</b>	240	80				
<b>9288DR</b>	288	96				
<b>9360DR</b>	360	120	2U	Dual	384 GB	2x 1.9 TB
<b>9504DR</b>	504	168				

More details are available at [www.arcserve.com](http://www.arcserve.com)



## 6 FAST AND FLEXIBLE RECOVERY OPTIONS

**Arcserve UDP offers all options for recovering systems and data in case of disaster or loss.**

### 6.1 Bare Metal Recovery (BMR)

If the physical system is damaged or destroyed, Arcserve UDP allows you to restore the entire Windows or Linux system to dissimilar hardware, even from a different vendor. Recovery does not require OS installation, and can be performed on empty, “bare metal” machines. BMR automatically adjusts OS configuration and injects missing boot-critical drivers to enable the recovered system to boot.

BMR can recover any system backup to any platform, including physical servers, virtual machines and cloud instances, and enables P2V, V2V, V2P, P2C, V2C, C2C and any other recovery and migration.

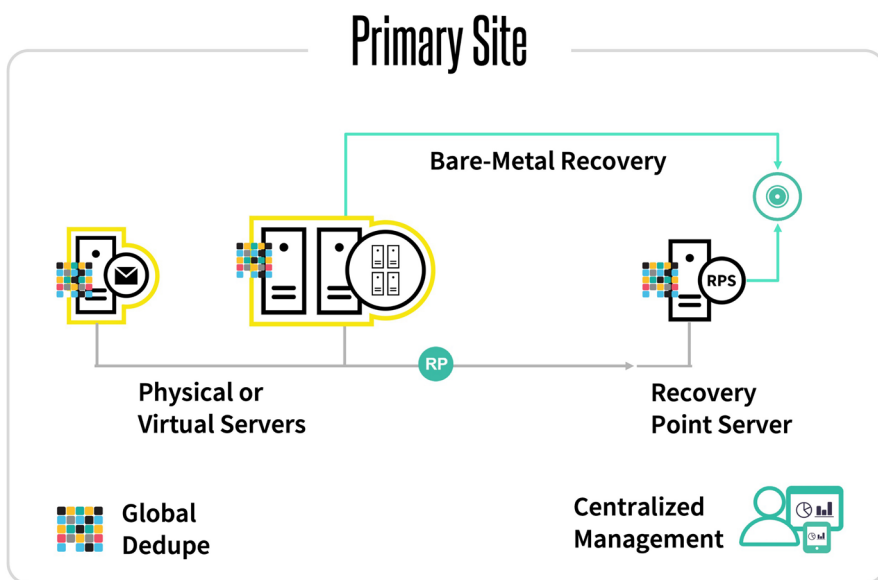

## 6.2 Virtual Standby

To reduce recovery times of business-critical systems, Arcserve UDP includes Virtual Standby functionality that automatically converts backups to a standby VM on VMware vSphere, Microsoft Hyper-V, Nutanix AHV, Amazon AWS or Microsoft Azure.

If a source production system goes down, Arcserve UDP can detect the failure via heartbeat and fail over operations by starting the standby VM.

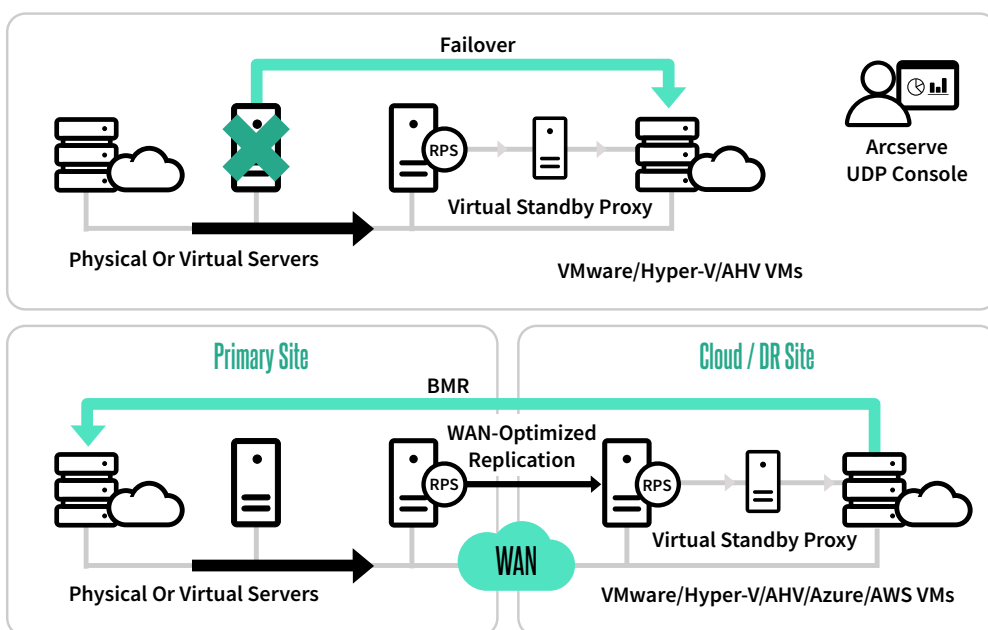

## 6.3 Instant VM

If the production system goes down, Arcserve UDP allows you to quickly spin up the virtual machine directly out of the backup storage, without the need to recover or rehydrate the backup first. Instead, Arcserve UDP mounts simulated storage drives directly to the hypervisor and provides the requested data on-the-fly.

With Instant VM, you can react quickly and reduce recovery times for business-critical systems, even if you have not prepared Virtual Standby, initially.

Instant VM supports physical and virtual Windows and Linux system backups, and can utilize VMware vSphere, Microsoft Hyper-V, Nutanix AHV, Amazon AWS and Microsoft Azure as the platform.

You can find all supported combinations in the [Arcserve UDP Compatibility Matrix](#).

## 6.4 Instant Bare Metal Recovery (BMR)

Instant BMR allows you to quickly spin up Linux systems directly out of the backup storage without full recovery or rehydration. While Instant VM uses the underlying hypervisor to mount simulated storage drives, Instant BMR uses Linux kernel capabilities to achieve the same goal – not just in virtual, but also in physical and cloud environments.



## 6.5 Application Recovery

Arcserve UDP system backups are application-aware and allow you to recover:

- **Microsoft Exchange** – entire servers or individual databases, mailboxes, folders or emails
- **Microsoft SharePoint** – entire applications or individual lists, libraries, documents or items
- **Microsoft SQL Server** – failover clusters, individual servers or select databases, including recovery to an arbitrary point-in-time with log rolling
- **Microsoft Active Directory** – domain controllers or individual objects
- **MySQL** – entire systems or individual databases
- **Oracle Database** – entire systems or individual databases, data files or tablespaces

## 6.6 Granular Recovery

If a file, folder or document is lost, Arcserve UDP allows you to granularly recover only the required item, without the need to restore the entire system. Arcserve UDP allows you to recover:

- Files or folders from backups of Windows/Linux systems, CIFS/NFS share, and Office 365 OneDrive for Business backups
- Databases, mailboxes, folders and individual emails from Microsoft Exchange and Office 365 Exchange Online backups
- Databases from SQL Server backups
- Datafiles and tablespaces from Oracle Database backups
- Active Directory objects, including OUs, sites, users, groups, computers and more, from Active Directory Domain Controller backups
- SharePoint lists, libraries and individual items from Microsoft SharePoint and Office 365 SharePoint Online backups

For most scenarios, you can recover the data to the same or new locations. You can also mount images of Windows and Linux file system volumes as virtual drives to recover files, folders or to perform advanced operations, like virus scans.

## 6.7 Assured Recovery

Arcserve UDP allows IT teams to perform Assured Recovery, scheduled automated Disaster Recovery testing to ensure business-defined RTOs and RPOs are met and the recovery is successful after a disaster or unplanned downtime event.

Arcserve Assured Recovery delivers:

- Disaster recovery testing of business-critical systems, applications and data in a sandbox, located on-premises, remote sites or in the cloud
- Non-disruptive process, which eliminates IT downtime and impact to production systems
- Detailed SLA reporting with RPOs and RTOs to prove your ability to recover systems and applications for stakeholders and auditors

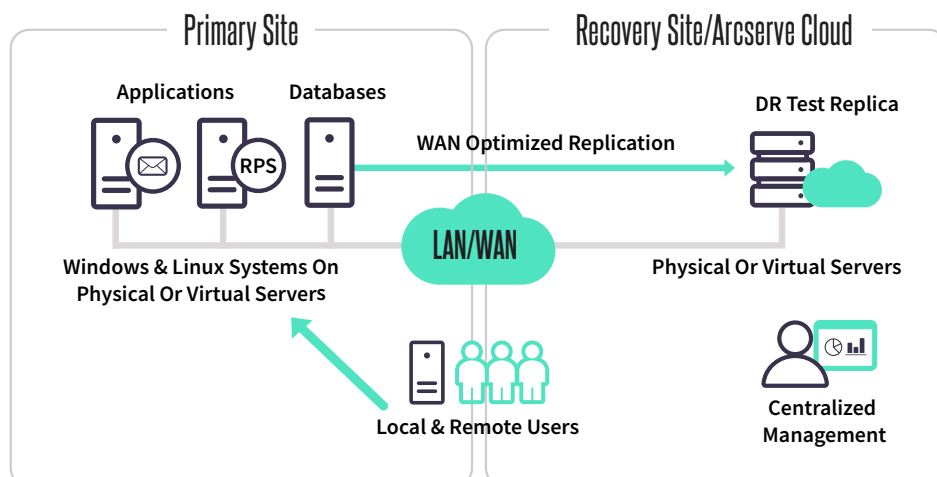

## 7 DEEP CLOUD INTEGRATION

Arcserve UDP supports Cloud Transformation initiatives by supporting all data protection scenarios that IT organizations face, whether the business is just starting the transition or fully embraces cloud technologies.

Arcserve UDP provides reliable and robust cloud integration, regardless of the stage in your cloud journey, with:

- **Cloud Disaster Recovery** – run critical systems in the Arcserve Cloud, AWS and Azure after a disaster
- **Cloud Backup** – store copies of your backups in the Arcserve Cloud, Amazon AWS, Microsoft Azure and more clouds
- **Amazon AWS and Microsoft Azure workload protection** – protect your cloud systems from data loss and extended downtimes
- **Microsoft Office 365 backup** – safeguard your emails, documents and files from data loss
- **Cloud Deployment** – install Arcserve UDP in Amazon AWS, Microsoft Azure, VMware vCloud Air, NTT Enterprise Cloud or Fujitsu Cloud Service for OSS for cloud-to-cloud backup with deduplication

### 7.1 Disaster Recovery in the Cloud

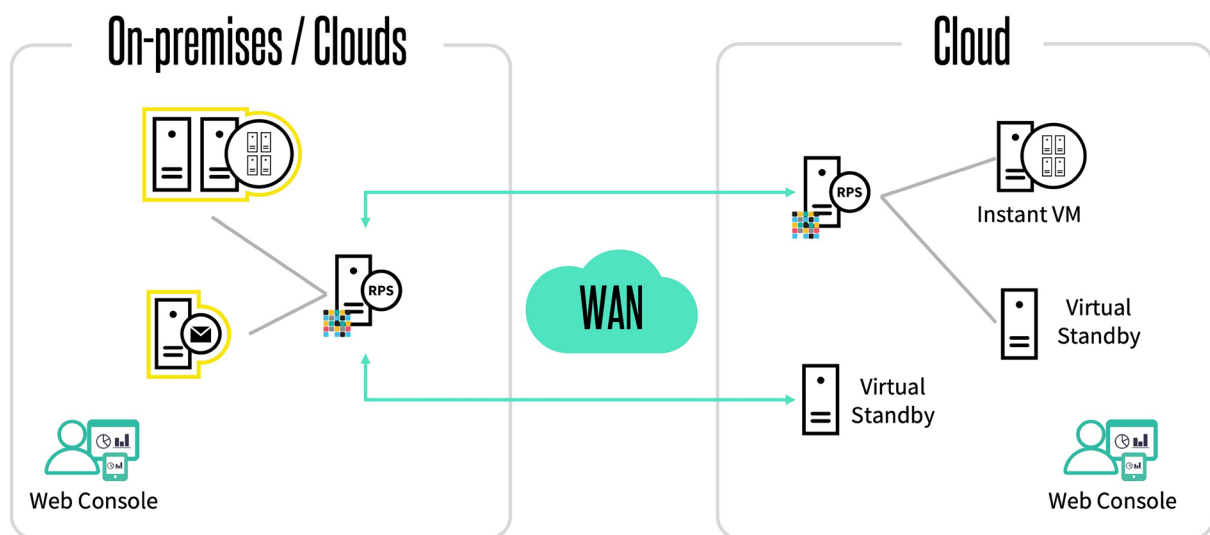

Cloud Infrastructure-as-a-Service (IaaS) is one of the best options for off-site disaster recovery of IT systems, offering availability even in the event of major disasters.

Arcserve UDP can spin up copies of your business-critical systems and applications in multiple clouds, including:

- **The Arcserve Cloud**, with Arcserve UDP Cloud Hybrid, a fully managed Disaster Recovery as-a-Service (DRaaS) add-on to Arcserve UDP software and appliances
- **Public Clouds**, including Amazon AWS, Microsoft Azure and compatible clouds to spin up Windows and Linux systems
- **Private Clouds**, including those powered by VMware vSphere, Microsoft Hyper-V, Nutanix AHV and other platforms



## 7.2 Backup to the Cloud

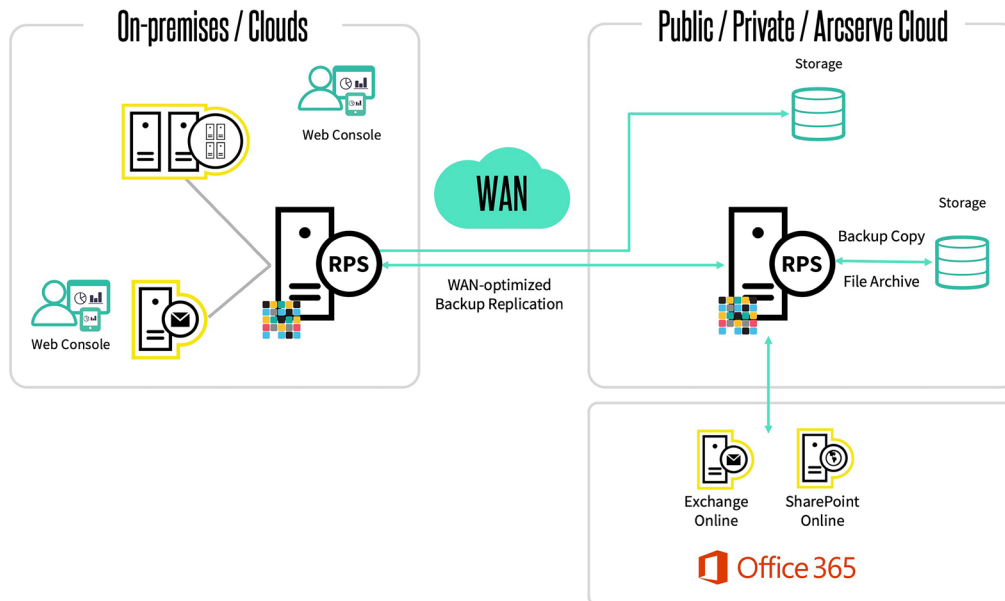

To protect critical data from loss during major disasters, it's advisable to store copies of backups off-site in the cloud. Arcserve UDP natively supports storing copies of your backups in:

- **Arcserve Cloud**, with Arcserve UDP Cloud Hybrid, an affordable, fully managed Backup as a Service (BaaS) add-on to Arcserve UDP software and appliances
- **Public Clouds**, including Amazon AWS, Microsoft Azure and compatible clouds.
- **Private Clouds**

You can choose to store backups directly on the cloud storage, including Amazon AWS S3 and Azure Blob Storage, or deploy a secondary Arcserve UDP RPS in the cloud to leverage native deduplication and WAN optimization.

## 7.3 Protect Workloads in Amazon AWS, Microsoft Azure and Other Clouds

While Amazon, Microsoft and other cloud vendors do an excellent job at taking care of the infrastructure for their cloud services, many IT organizations incorrectly assume that they also include backup with point-in-time recovery, or recovery of data lost or corrupted by employees.

Many cloud vendors operate a shared-responsibility model, meaning they take responsibility for the software and physical security of their data centers, but it's the responsibility of each customer to protect data from human error, internal and external security threats, and programmatic issues.

In short, it's your responsibility to protect your cloud data and workloads from loss and corruption.

Arcserve UDP protects your cloud-based systems by creating backups in-cloud, on another cloud, or on-premises with the same advanced capabilities available for on-premises system protection and recovery.



## 7.4 Protect Microsoft Office 365

### 7.4.1 Protect Emails in Exchange Online

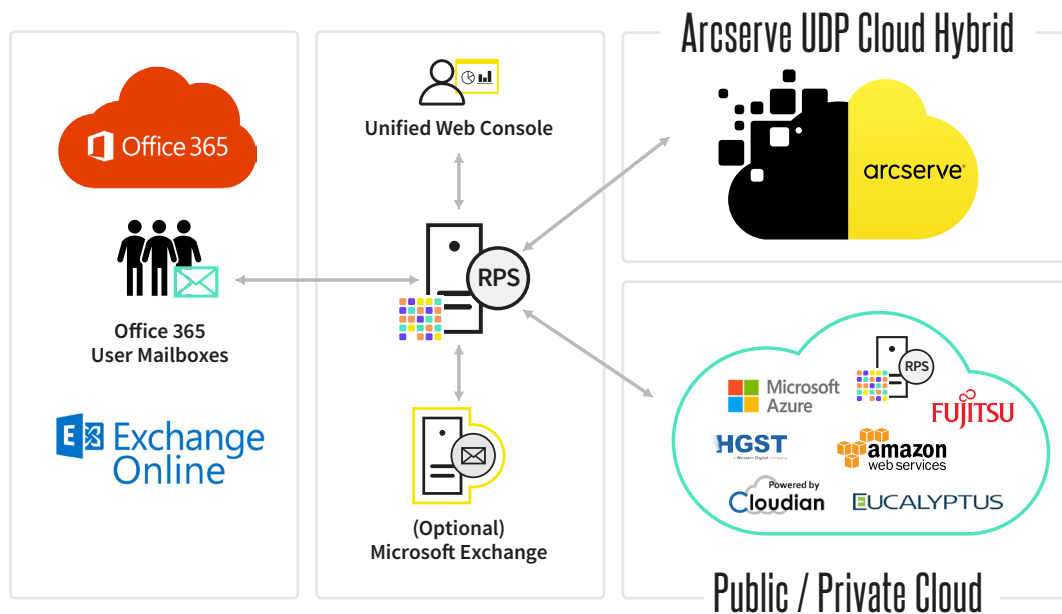

Much like hyperscale cloud providers, Microsoft Office 365 is limited in what recovery services are available – yet 92% of IT organizations incorrectly assume that Office 365 includes point-in-time recovery of data.

Arcserve UDP allows you to regain control of your data with the most complete set of data protection capabilities available for Office 365, and deployed with one web-based user interface.

Arcserve delivers robust Exchange Online backup and point-in-time granular recovery so you always have a separate copy of your data available.

Securely back up an entire organization or select mailboxes to your on-premises storage, to your data center or to your cloud on the schedule you define and control, and:

- Quickly recover mailboxes, folders or individual emails via a unified, web-based UI
- Reduce storage capacity requirements with built-in global deduplication
- Copy backups to tape devices, tape libraries and cloud storage, including Amazon S3 and Azure Blob Storage
- Maintain corporate and government compliance, including GDPR article 32 section 1a, with AES encryption and role-based access control
- Migrate to Exchange Online safely by protecting your on-premises Exchange using the same UI and policies
- With Arcserve UDP, you can efficiently increase your retention periods for Exchange Online for months, and even years, to comply with corporate and government regulations.





### 7.4.2 Protect SharePoint Online Sites

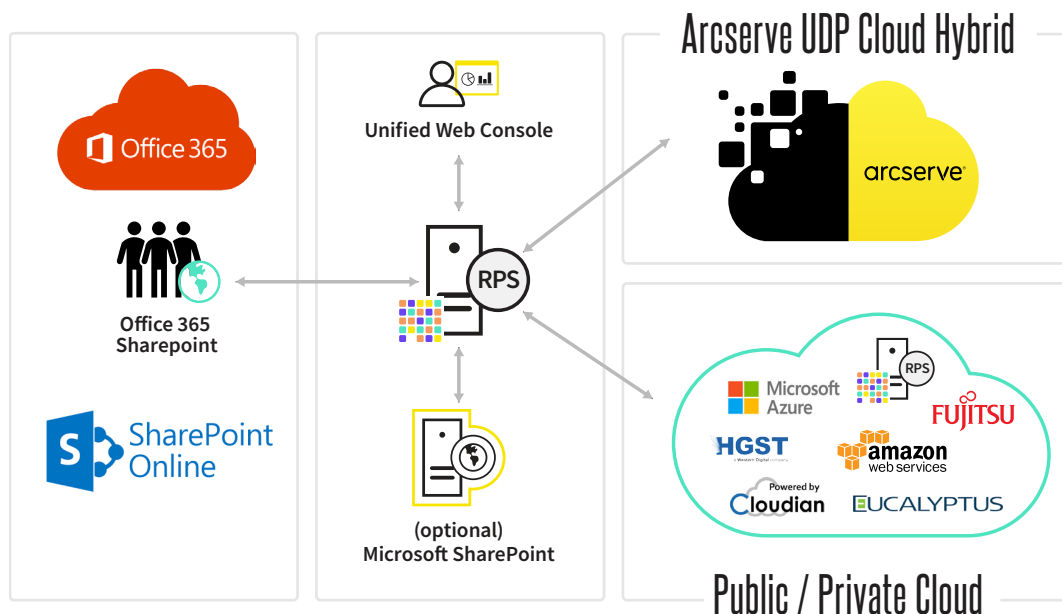

Reliable SharePoint Online backup and point-in-time granular recovery with Arcserve UDP keeps your data online and secure, allowing you to:

- Recover an entire site collection, or select lists, libraries and documents from the point in time copy
- Reduce storage capacity requirements with hyper-efficient, built-in global deduplication
- Copy backups to tape devices, tape libraries and cloud storage, including Amazon S3 and Azure Blob Storage
- Migrate to SharePoint Online by protecting your on-premises SharePoint from one unified console for all your workloads

### 7.4.3 Protect User Files on OneDrive for Business

Arcserve UDP safeguards user files with comprehensive OneDrive for Business backup, enabling you to back up all or select specific OneDrive accounts, and:

- Quickly recover files, folders or entire accounts
- Store backups on-premises and in cloud disk storage with built-in global deduplication
- Copy backups to tape devices, tape libraries and cloud locations, including Amazon S3 and Azure Blob Storage

## 7.5 Deploy Arcserve UDP in the Cloud

Even if your organization has completely transitioned to cloud and eliminated all its on-premises data centers and workloads, you must still protect your them from data loss or disasters.

Arcserve UDP can be fully deployed in Amazon AWS or Microsoft Azure without requiring any on-premises resources. Protect any system or data, store the backups in the cloud, and manage the entire process via a single web-based user interface, wherever you are.



## 8 COMPREHENSIVE BACKUP AND MANAGEMENT

### 8.1 Data Protection Plans

Arcserve UDP centralizes and simplifies protection of the entire IT infrastructure with orchestrated and customizable sets of rules and task flows to protect multiple systems – automating the entire data protection lifecycle, including backup, replication, Virtual Standby and more.

Arcserve UDP plans allow administrators to focus on business objectives and service levels, unifying protection for systems with similar data protection requirements, yet retaining granularity required by stakeholders.

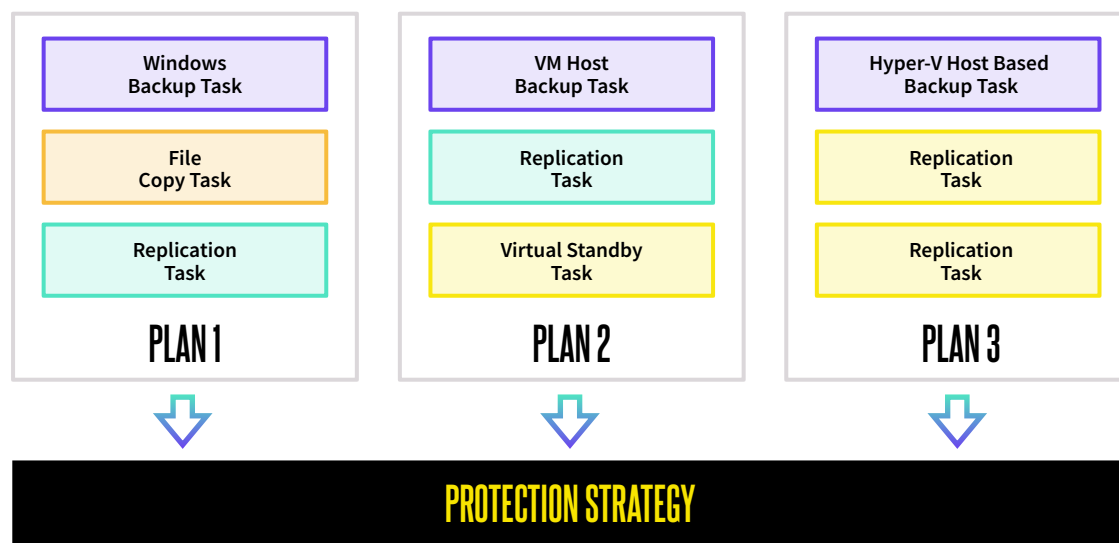

### 8.2 Global Source, Block-Level Deduplication and WAN optimization

Arcserve's proprietary deduplication technology eliminates duplicate blocks of data during the backup process, allowing you to:

- Save up to 95% storage capacity with **block-based** deduplication that removes redundancies inside files and data
- Diminish storage needs even further with **global** deduplication that removes duplicate blocks across your entire IT – all sources, data and backup plans, not just from a single backup
- Reduce network bandwidth needs by up to 20x with WAN optimization, as **source** deduplication transfers only unique data from backup source to the RPS
- Ensure the security of your data with SSL **encryption** in-flight and strong AES encryption at-rest

The deduplication database can be stored on SSDs or in the RAM, depending on the available options and performance needs. It supports all types of backups, including: physical Windows/Linux systems, virtual agentless backups of VMware vSphere, Microsoft Hyper-V, Nutanix AHV, cloud backups of Amazon AWS EC2 instances and Microsoft Azure VMs, file backups of CIFS/NFS shares, Office 365 Exchange Online, SharePoint Online and OneDrive for Business.



### 8.3 Backup Replication and Retention

Arcserve UDP includes advanced multi-destination replication and backup retention features to ensure reliable recovery from local and major disasters, allowing you to:

- Copy backups to remote locations and the cloud, with RPS to RPS replication
- Implement a 3-2-1 data protection strategy with support for disk to disk to cloud (D2D2C), disk to disk to disk (D2D2D) and disk to disk to tape (D2D2T), as well as other schemes to satisfy your requirements, corporate and government regulations
- Manage connection loads and costs with built-in WAN optimization, compression and bandwidth throttling
- Avoid issues with temporary WAN instability with automated, link-failure resistant resynchronization
- Assure reliable replication with replication verification
- Maximize performance with multi-streaming and parallel replication
- Assure security with SSL encryption in flight and strong AES encryption at rest

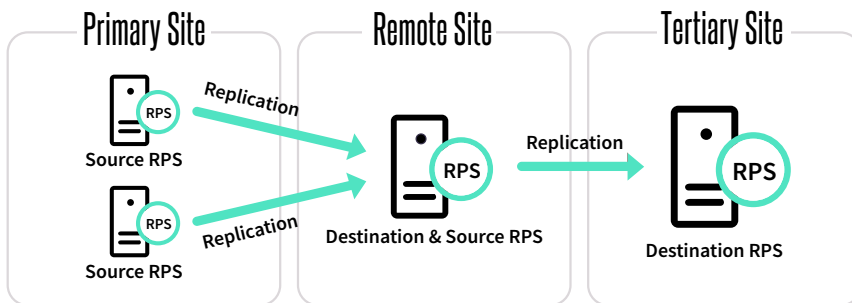

### 8.4 Hardware Snapshots

When you use Storage Area Network (SAN) to store data, Arcserve UDP can leverage SAN snapshot capabilities for backups to reduce resource requirements on the production workloads.

Arcserve UDP integrates with your SAN to request snapshot creation and then backs up physical servers, applications or VMs directly from the SAN snapshot.

The process is fully automated – after a simple configuration, the hardware snapshots can be enabled by a single setting in your data protection plan.

Arcserve UDP natively integrates with hardware snapshots on NetApp, HPE 3Par, Nimble and Dell EMC Unity.

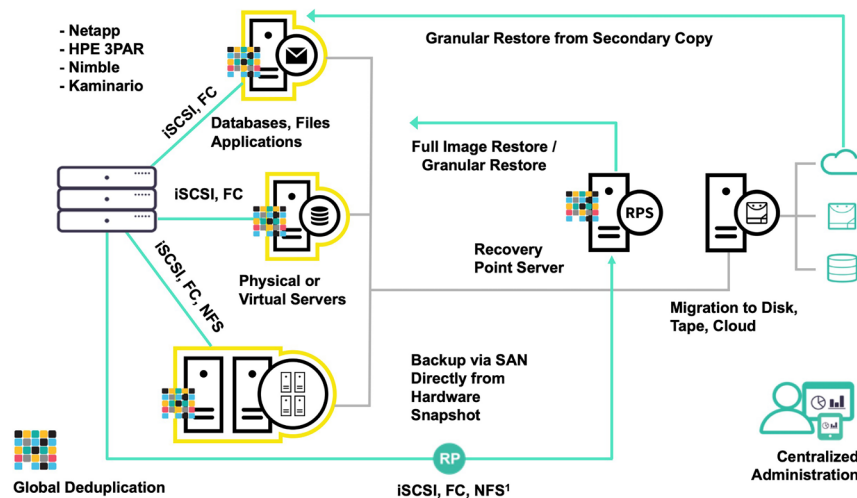

## 8.5 Tape Integration

Arcserve UDP strengthens your regulatory and corporate compliance and enables cost-effective long-term retention with advanced tape support for offsite backup, archiving and disaster recovery.

Arcserve UDP tape support is powered by Arcserve’s foundational solution, Arcserve Backup - a proven and reliable tape backup solution that’s protected businesses for decades, and is certified and tested with hundreds of tape drives, tape libraries, optical media jukeboxes, VTLs and more.

With Arcserve UDP, you can:

- Copy individual backup Recovery Points to any tape device, rehydrating the deduplication in the process to enable fast granular recovery
- Copy entire UDP Data Stores to tape, preserving deduplication to save tape capacity and enabling quick recovery of the entire backup infrastructure after disasters
- Arcserve Backup is included with most Arcserve UDP licenses. More details are available in the [Arcserve UDP Licensing Guide](#).

## 8.6 RPS Jumpstart or “Offline” Synchronization

Arcserve UDP reduces connection bandwidth requirements with forever-incremental backups and WAN optimization to ensure only unique, new data is replicated to remote sites.

However, because the initial backup is full and includes your entire data set, replication over the wire may take significant time. For example, transferring 20TB of data over a 100Mbit connection may take up to 60 days to complete, while WAN-optimized incremental backups could take just hours.

Arcserve UDP solves this challenge with RPS Jumpstart, or offline synchronization, which allows you to save RPS datastores to a portable device (external drives or NAS) and seed a remote site by physically shipping the data to a remote location. With RPS Jumpstart, you can significantly save time, especially if the data amount is substantial and connection to a remote site is limited.

This feature can also be used to jumpstart RPS in private and public clouds offering seeding services.

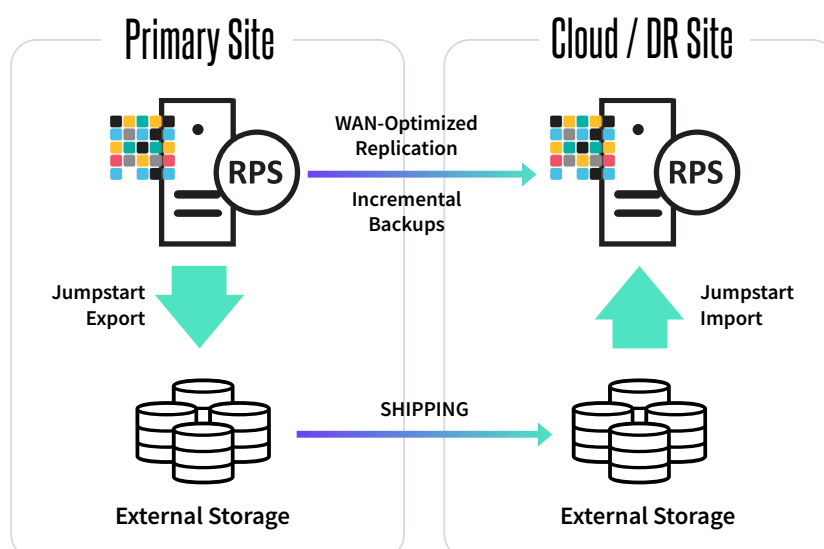

## 8.7 Storage Multi-Tenancy

Arcserve UDP enables MSPs and distributed IT teams to store backups in one central location while assuring security, isolation and privacy of customer and user data.

Customer and user backups are replicated from the local RPS to the central RPS, where they are isolated with encryption and a plan password. Central MSP/IT Administrators cannot access the data without this password.

At the same time, data is deduplicated across the entire centralized storage, improving efficiency, reducing storage requirements and enabling WAN optimization.

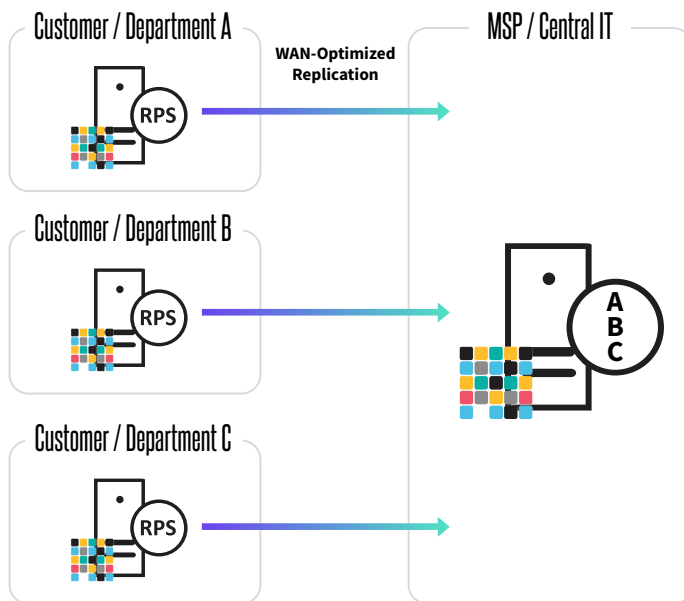

## 8.8 Monitoring, Alerting and Advanced Reporting

Arcserve UDP keeps IT professionals in control and reduces complexity of backup management with:

- Innovative monitoring capabilities through one centralized dashboard
- Flexible alerting to reduce time-to-resolution of temporary issues with backups
- Advanced reporting with many preconfigured and customizable reports

Research has shown these capabilities have reduced the time spent managing backups by up to 50%.

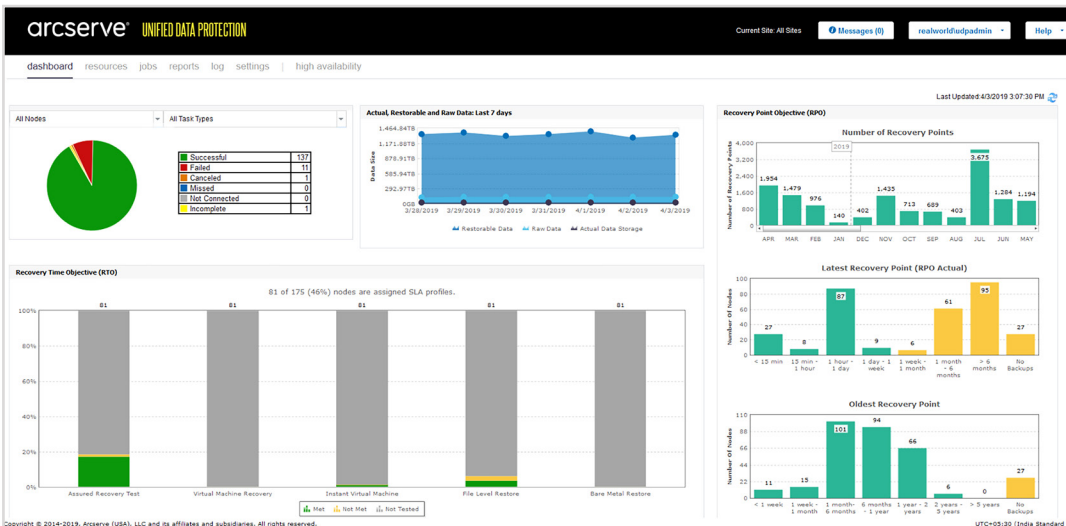
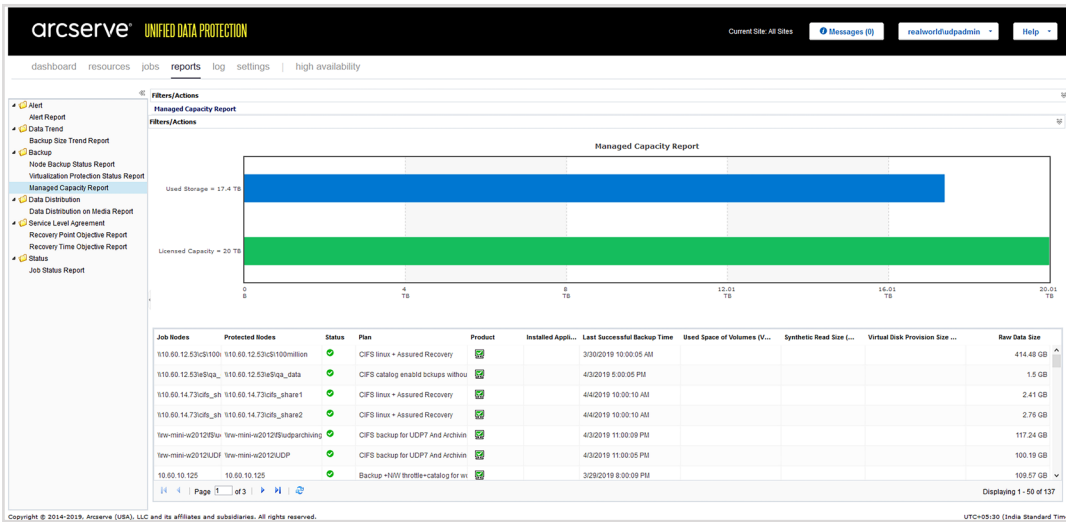

## 8.9 Role-Based Access Control

Arcserve UDP is designed to scale from small environments to very large installations where there could be multiple people with different access rights, roles and authority. Role-based access control (RBAC) functionality allows corporate administrators to assign different roles and access permissions to AD/LDAP users, controlling access to different features with the Arcserve UDP Console, including:

- Backups
- Source Nodes, systems and data
- Data stores within RPS
- Recovery operations
- Monitoring and reporting
- RHA integration

To simplify the security configuration, Arcserve UDP comes with four predefined roles with pre-configured access rights:

- Backup admin
- Monitor
- Restore
- RHA admin

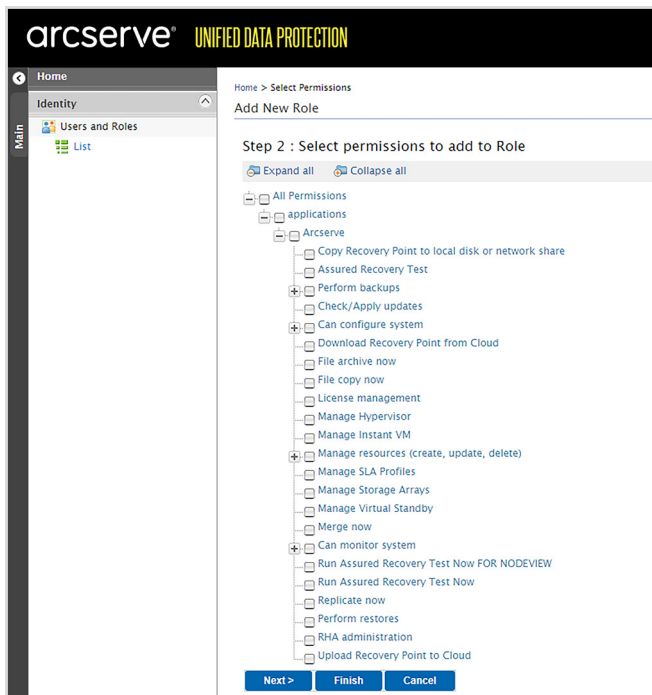

## 9 SUMMARY

Arcserve UDP combines industry-proven disaster recovery, backup and true global deduplication technologies into an all-in-one solution that delivers every data protection capability you and your business need through one stunningly simple management console.

Powered by heterogeneous, image-based technology that protects to and from any target, it unifies enterprise-ready features without the complexity of traditional solutions.

Eliminate the need for discrete products, and:

- **Safeguard** your systems and applications in cloud, virtual and physical environments
- **Reduce** the risks of extended downtime by cutting RTOs and RPOs from days to minutes
- **Scale** up, down and out to the cloud on-demand, turning capabilities on and off without forklift upgrades
- **Validate** your RTOs, RPOs, and SLAs with built-in Assured Recovery™ testing
- **Amplify** storage efficiency by up to 20x with built-in global, source-side deduplication
- **Reclaim** up to 50% more time to spend on strategic IT initiatives

Find more details and to get a trial version, please visit the Arcserve website: [www.arcserve.com](http://www.arcserve.com).

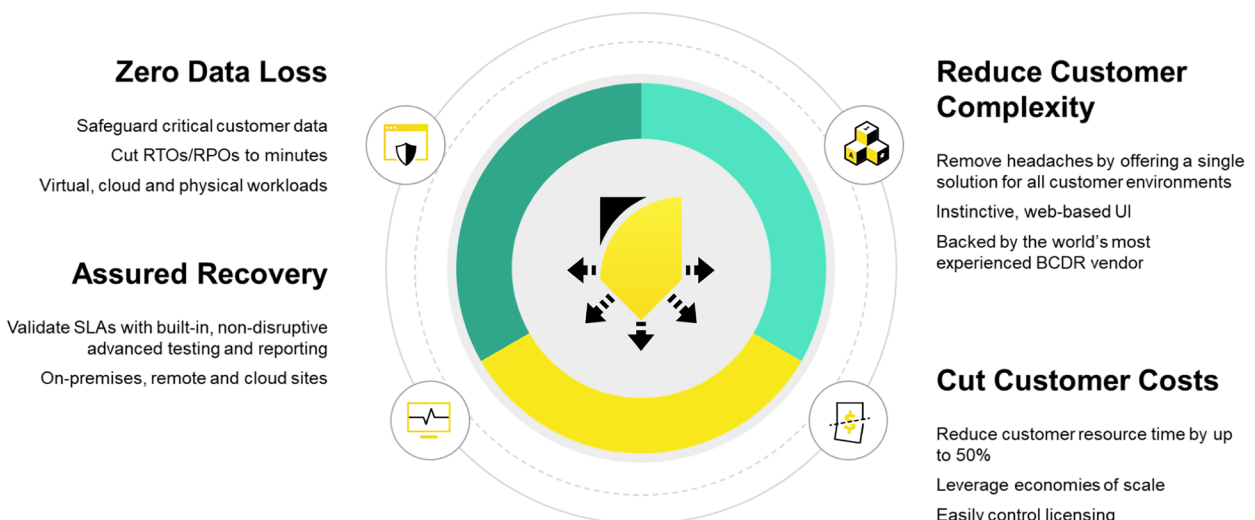

## 10 ABOUT ARCSERVE

Arcserve provides exceptional solutions to protect the priceless digital assets of organizations in need of full scale, comprehensive data protection. Established in 1983, Arcserve is the world's most experienced provider of business continuity solutions that safeguard multi-generational IT infrastructures with applications and systems in any location, on premises and in the cloud. Organizations in over 150 countries around the world rely on Arcserve's highly efficient, integrated technologies and expertise to eliminate the risk of data loss and extended downtime while reducing the cost and complexity of backing up and restoring data by up to 50 percent.